

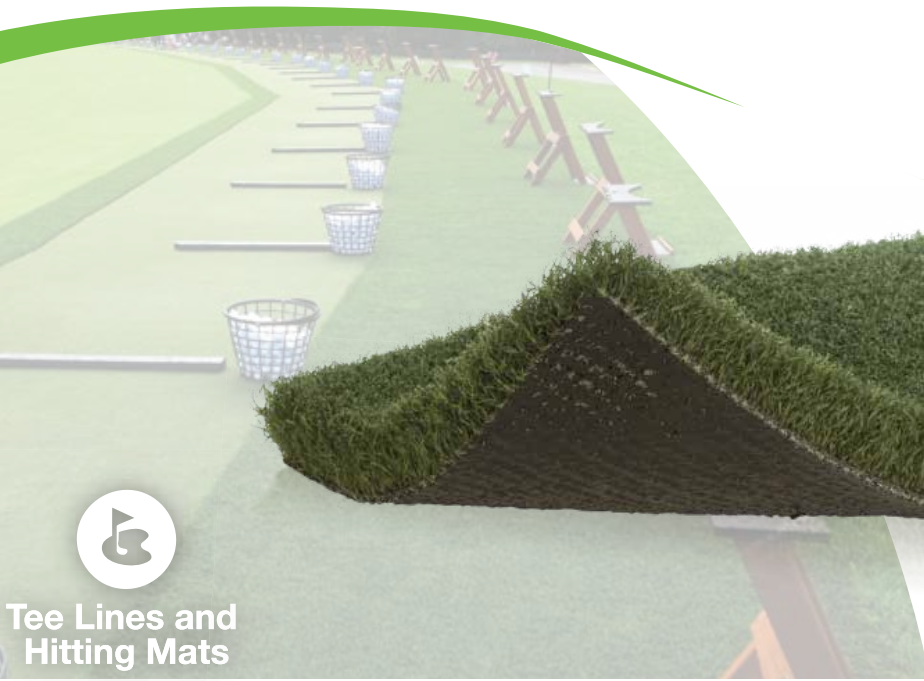

Eziee POLY



Tee Lines and
Hitting Mats



PROPERTY

Primary Yarn Polymer

Yarn Cross Section

Standard Colors

UV Stabilized

Fabric Construction

Primary Backing

Coating Type(s)

Perforations

Recommended Infill

Pile Height

Total Weight

ISO 9001 Quality Assured

Roll Width

DESCRIPTION

Polypropylene

Texturized Polypropylene

Pine

Yes

Cross-stitched

Dual Layered Woven Polypropylene

SilverBack™ Polyurethane

No

N/A

1 1/8"

147 oz.

Yes

12 & 15 ft.

ADVANTAGES

- Holds a real tee
- Allows for a true natural swing
- Provides a divot feel with no club bounce
- Used by PGA professionals, teachers, tour players and numerous top rated facilities
- Drastically improves your golf game
- Allows for play and practice year round
- Saves your grass and your money
- Available in mats and full tee lines



EZtee POLY

BENEFITS

The EZTee® Poly features a non-infilled high grade polypropylene yarn system designed for heavy traffic tee lines, hitting mats, and extended use golf ranges. This product holds a real tee and allows players to hit all clubs, from a wedge to a driver and is used by many of the top golf courses around the world. EZTee® Poly does not replace your natural grass, but instead gives the grass time to heal properly. When will you Experience A Greener World and a better golf facility?

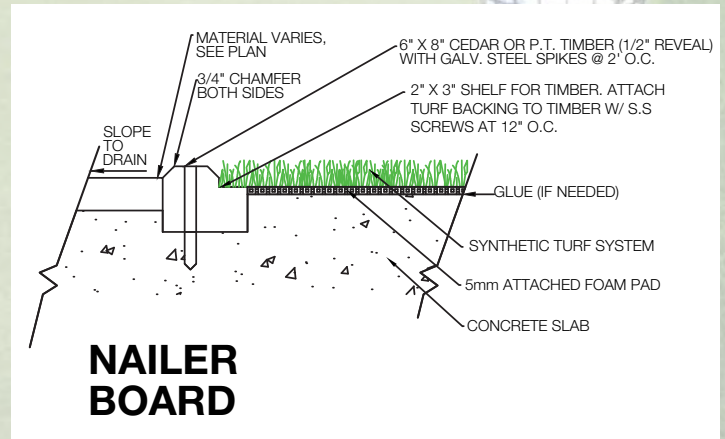
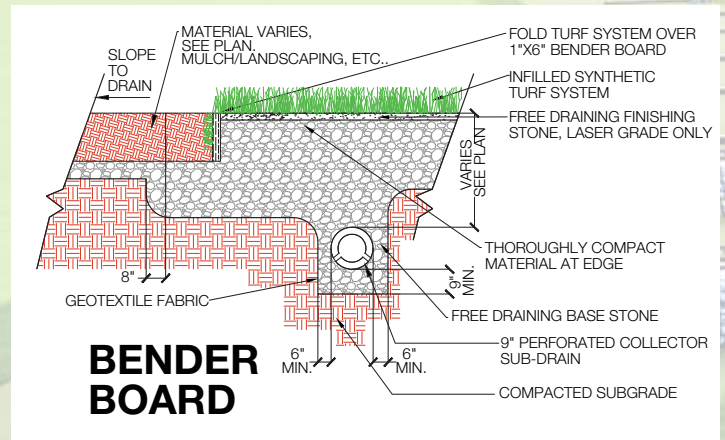

It is the policy of Synthetic Turf International to continuously improve their line of products. Therefore, Synthetic Turf International reserves the right to change, modify or discontinue systems, specifications and accessories of all products at any time without notice or obligation to purchaser. These are standard specifications subject to manufacturing tolerances and consumer requests.